

**lamart**  
*by Pierre Lamart*

**CZ** Návod k obsluze tlakového hrnce  
**EN** Pressure cooker user's manual  
**SK** Návod na obsluhu tlakového hrnca  
**PL** Instrukcja obsługi szybkowaru  
**HU** Kukta használati útmutató  
**RU** Руководство пользователя скороварки

**HR** Priručnik za uporabu ekspres lonca  
**SI** Navodila za uporabo lonca na pritisk  
**DE** Schnellkochtopf Bedienungsanleitung  
**FR** Manuel utilisateur de l'autocuiseur  
**IT** Manuale d'uso della pentola a pressione  
**ES** Manual de usuario de la olla a presión

**CUIRE**  
**51**

**Parts list of the pressure cooker (see picture):**

- 1) Handle with the One-hand opening system
- 2) Clip plate mechanism
- 3) Overpressure safety
- 4) Pressure cooker lid
- 5) Jaw type lid lock with gasket seal
- 6) Clip mechanism
- 7) Silicone gasket ring
- 8) Pressure cooker pot
- 9) Massive handles
- 10) Air valve
- 11) Work (pressure) valve
- 12) Pressure control mechanism
- 13) Digital timer

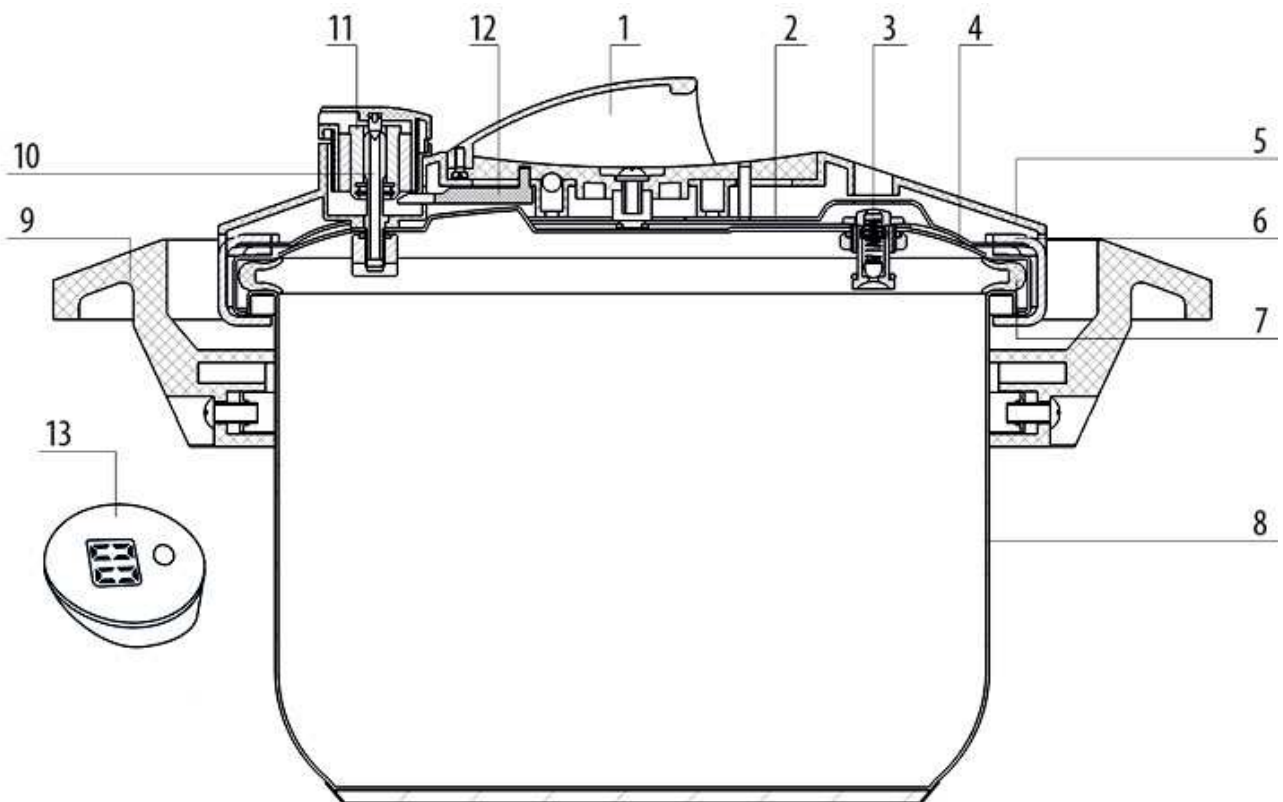



**EN** Congratulations on purchasing the LAMART brand CUIRE pressure cooker by Piere Lamart - manufactured from first-class 18/10 stainless and very durable plastic. Before first use, carefully read these instructions including notes and store them for future use! High standard materials were used in order to ensure the safety and long lifetime of this pressure cooker. We hope that it will be a pleasure to use.

## IDENTIFICATION

**Manufacturer:** Zhejiang Duobao Industrial&Trade Co.,Ltd

**Type/Volume:** DSD22 type 5L

**Working pressure I (bar):** 60 Kpa

**Working pressure II (bar):** 80 Kpa

**Maximum permitted pressure (bar):** 160 Kpa

## DESCRIPTION:

The CUIRE pressure cooker is manufactured from first-class 18/10 stainless steel - it provides an easy and hygienic way to prepare meals. The pressure cooker is equipped with massive side and lid handles made from durable plastic that does not burn. The pressure cooker is equipped with a safety and work valve, which ensure maximum safety when using the product under pressure. The sandwich bottom of the pot has outstanding heat-accumulation properties so only a minimal amount of power is needed from the stove, thus providing energy savings. The pressure cooker is suitable for all types of stoves: gas, halogen, electric, glass ceramic and induction hotplates.

## IMPORTANT SAFETY INSTRUCTIONS

1. Please read the manual carefully before first use
2. Persons that have not been informed about the methods of using the pressure cooker should not handle it
3. Never leave the pressure cooker without supervision during the cooking phase while it is under pressure
4. Be especially careful if you will be using the pressure cooker near children. It is forbidden for children to handle the pressure cooker
5. Only use the pressure cooker for the purpose of fast cooking for which it was designed. When cooking, handle the pressure cooker with care – do not touch the hot parts of the cooker
6. Before every use, check the condition and working order of the safety valve, the control valve and the gasket ring
7. Because pressure accumulates inside the cooker during the cooking process, it is necessary to firmly close the lid before every use. Carefully read the operating and safety instructions in the user's manual. If this is not done - improper use may lead to injuries to people or damage to the cooker.
8. This pressure cooker is equipped with a pressure gauge. Look for steam escaping from the control valve - this indicates a sufficient pressure inside the cooker. You must allow the pressure cooker to cool down before opening it. The accumulated pressure must be released, otherwise it will not be possible to open the pressure cooker.
9. Never exceed the prescribed minimum capacity of the cooker (= liquid + cooked food).
10. Never exceed the prescribed maximum capacity of the cooker (= liquid + cooked food). Always fill the pressure cooker to 2/3 of the volume of the pot when cooking food, which increases its volume such as legumes, rice, pasta (when cooking pasta, prior to opening, shake the cooker to prevent food from being ejected), vegetables, etc. Never cook without using water.
11. Do not cook food wrapped in paper, fabric or plastic packaging materials inside the pressure cooker. When cooking foods that have increased their volume, e.g. meat with skin, beef tongue, etc., be very careful not to pierce the outer layer – risk of scalding.
12. Only use the pressure cooker on sources of heat described in the user's manual.
13. Only use this pressure cooker for the purpose of fast cooking for which it was designed. It can also be used like a normal pot without the lid. Never use it in a normal oven or in a microwave oven.
14. The cooker must never be used under pressure for baking or frying on oil.
15. Never use the pressure cooker inside an oven as this could damage it.
16. Follow additional notes regarding the cooking of special foods.
17. Always hold the pressure cooker by its handles.
18. If the pressure cooker is still hot, you can handle it only with increased care and hold it only by the handle on the pot and

not by the handle on the lid. To protect your fingers, also use a wiping cloth.

19. Never attempt to open the pressure cooker using force. Check that the pressure has fallen before opening the pressure cooker.
20. When releasing the steam, keep your hands, head and body outside the range of the steam.
21. The lid of the pressure cooker is not to be washed in a dishwasher.
22. Always use ORIGINAL spare parts. You should use only original accessories and spare parts or lids and pots because they have been designed specifically for these pressure cookers.
23. If repairs are necessary, please contact our customer service.
24. Stains on the bottom of the pressure cooker can easily be removed using a lemon or vinegar.
25. Under no condition should you use coarse cleaning agents or steel wool for cleaning.
26. Store these instructions in a safe place.
27. Do not modify the safety mechanism in any way, otherwise there is a risk of scalding. When releasing the steam, keep your hands, head and body outside the range of the steam.
28. A pressure cooker or accessories that are in any way damaged or deformed should not be used under any circumstances.
29. Take care not to come into contact with hot steam.

### OPERATING MANUAL:

Before first use: Remove all protective elements from the pressure cooker and tear off and clean away all stickers. Wash all parts using warm water and a sufficient amount of detergent and dry thoroughly.

Before every use: always check all the safety elements: work and safety valves – check the working order by pushing them down. The valve should always return to its original position.

### Operating instructions:

#### 1) Opening

The One-hand system is a revolutionary opening mechanism. Turn the handle with one hand to the open position. The jaws will snap open and the released lid can be removed by lifting it up.



#### 2) Closing

Place the lid on to the pot. Make sure that the jaws are open. Then use one hand to again turn the handle from the open position to the closed position and the jaws will snap to grab the edge of the pot.

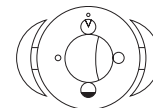

#### 3) Inserting food

Place the food that you wish to cook into the pot (ensure that the minimum amount of liquid is added). The minimum level of the liquid and food should be at least at 1/3 of the pressure cooker. Now add everything that you want to cook. If the food swells, increases in volume or foams, then only fill the pot to half, i.e. the liquid and food must not exceed 1/2 of the pressure cooker. You can fill the pot up to 2/3 of the total volume of the cooker (liquid and food) when cooking all other food.

#### 4) Setting a level

- I = gentle cooking
- II = rapid cooking

#### 5) Preparing the stove

Set the stove to the highest power level. Cooking in the pressure cooker starts with the placement of the pot on to the stove.

As soon as steam begins to escape from the work valve, turn the stove to a lower level. After the necessary cooking time elapses, turn the stove off.

#### 6) Cooking and releasing steam

Slowly and carefully release the steam or wait until the pressure falls completely.

Slowly turn the pressure valve from position II to position I for a few seconds and then to the pressure release position .



Never turn the work valve from position II to the pressure release position .

If you are cooking at level I, you can turn it directly to the pressure release position .

**WARNING:** escaping steam is extremely hot. Other methods for lowering pressure are described on the following pages.

## 7) Ending the cooking process

Wait until all the steam escapes from the pressure cooker before opening it and then you can turn the pressure cooker off. You can open the lid and carefully remove the food.

**WARNING:** never open the lid using force, the lid may still be hot

## SAFETY SYSTEMS AND THE LID

This pressure cooker provides you with many advantages and safety elements:

The two-level pressure valve together with the instructions and the cooking time table can sometimes be used as a guide. That is why this pressure cooker has a two-level pressure value. The advantage of the following indicator is that it makes it possible, based on the size and amount of food that you wish to cook, to set the pressure in the pressure cooker individually using the valve. Refer to the time table at the end of this user's manual where you will find the basic settings. You will cook much healthier meals. Your food will be cooked very gently because you will cook it for a shorter time in steam without oxygen. Every minute saved represents more important vitamins, nutrients and minerals that are saved. The food you cook will taste better. Cooking without oxygen significantly helps in retaining flavour and the natural colour of your vegetables. You will cook faster and save time and energy. Using this pressure cooker will save you up to 70% of the time that you have spent cooking until now.

Furthermore, you will save energy, up to 60% for dishes with a longer cooking times and 30 - 40% for dishes with shorter cooking times.

Further safety elements are described below.

### PRESSURE VALVE:

for continuously variable cooking settings. The valve automatically maintains pressure and heat at the required setting:

Position I (gentle cooking) - 60 kPa - approximately 113 °C

Position II (rapid cooking) - 80 kPa - approximately 120 °C

The pressure valve can also be set to a pressure release position  and a position for cleaning the valve.

Safe pressure is 1.6 bar (160 kPa) - the valve opens and pressure is released, the maximum permitted pressure for this pressure cooker is: 2.7 bar (270 kPa).

### SAFETY VALVE:

A RED pressure indicator (overpressure plug) can be seen while the pressure in the pressure cooker is rising; the pot is locked at this time (never attempt to open the lid by force).

If the pressure indicator is not visible, there is no more pressure in the pressure cooker. You can open it. If for whatever reason the control valve does not release pressure as it should, the valve will open in accordance with the prescribed values.

### ONE-HAND OPENING / CLOSING SYSTEM:

Use one hand to open and close the lid by turning the handle in the top part of the lid. Once you have turned the handle, you can remove the lid from the pot or return it on to the pot later if necessary. Warning! Release all steam before opening the pressure cooker - never attempt to open the pressure cooker by force!

### SAFETY WINDOW

An additional safety element is the safety viewing window in the lid. In the event of excessive pressure inside the pressure cooker, the gasket ring will deviate into this window and thereby steam can escape.



### LID WITH A GASKET RING

Gasket rings wear out and if necessary must be replaced with new ones. Important: Only use original gasket rings.

## USING THE DIGITAL TIMER:

The timer is one control button with the option of the following functions: turn on, start countdown, restart, turn off.

- 1) The timer is always in the off mode. To start it, press the button once. If you do not set the next step on the timer within 60 seconds – the timer will turn off automatically.
- 2) After starting the timer, every time the button is pressed, 1 minute is added to the maximum countdown setting of 30 minutes. In order to speed up the timer setting process, it is possible to hold down the button for longer than 1 second to adjust the countdown. The timer will start counting down the set time after approximately 2 seconds (the display will start flashing).
- 3) It is possible to stop the time during the countdown by pressing the button. If the button is held down for at least 2 seconds this will reset the timer – i.e. a system reset. If you do not use the timer in the following 60 seconds, it will turn off automatically.
- 4) After completing the countdown, 2x alarm signals will be made.

The first sound signal is made between the 1st and 20th second of the countdown. In the following 10 seconds (between the 21st and 30th second) the timer will be silent. The second signal is then made between the 31st and 50th second after finishing using it. If you do not continue using it by setting another timer function after the second signal is made – again after 60 seconds it will turn off automatically. While the sound signal is being made, you can press the button to interrupt the alarm bringing the device back to 0 – reset.

**ATTENTION:** The timer must not come into contact with direct water. In the event of cleaning and washing the lid of the pressure cooker, first move the timer out of reach to prevent it from being damaged.

## POT

### POT:

This pot - with its attractive and timeless appearance - is made from high quality 18/10 stainless steel, it is easy to maintain and can be washed in a dishwasher (WITHOUT THE LID). Without the lid, it can be used like a normal pot.

## SANDWICH BOTTOM OF THE POT:

A super strong bottom suitable for all stove types. It is absolutely stable, guarantees the best thermal properties and saves energy.



## DETAILED COOKING PROCESS

### BEFORE STARTING TO COOK:

Prior to every use, make sure that the safety locking system, pressure valve and the gasket ring are clean and in full working order. In particular, check that the safety valve on the underside of the lid can move. Using a sharp item, check that the pin freely moves (against the pressure of the spring). Fill the pot with a sufficient amount of liquid (water, bouillon or sauce) so that the necessary steam can be generated.

**WARNING:** Always use a sufficient amount of liquid. NEVER allow the pressure cooker to „dry cook“. Now add everything that you want to cook. The liquid and food intended for cooking should reach at least 1/3 of the pressure cooker. No more than 1/2 with food that swells or foams. No more than 2/3 for all other food. Please, always keep an eye on the scale located on the inner side of the pressure cooker. Check that there is enough space between the food that is to be cooked and the lid with the safety valve.

### COOKING in a pressure cooker is so easy...

- 1) Select the desired cooking level using the pressure valve: Set the pressure level - I = gentle cooking or II = rapid cooking
- 2) Set the stove to the highest power level.
- 3) Place the pressure cooker with the set pressure level on to a hotplate and turn it on to the highest level. The red pin of the safety valve (overpressure plug) will appear when the pressure increases. From this point on, you must not open the pressure cooker.
- 4) The time necessary to achieve the set pressure level depends on how full the pressure cooker is. This moment is when steam starts to continuously escape from the pressure valve. The actual cooking time starts precisely at this moment. At this moment you should switch the stove to the lowest level.
- 5) At the end of the cooking time, turn the stove off.
- 6) Slowly gradually release the steam or wait until the pressure falls completely. Slowly turn the pressure valve from position II to the pressure release position . Do not turn it directly from position II to position . First turn it from







position II to position I and wait a few seconds and then continue to turn it from position I to position . If you are cooking at level I, you can turn it directly from position I to position .

**WARNING:** Unikající pára je velmi horká - chraňte se před popáleninami a opařením vašeho obličeje, těla nebo rukou.

7) Wait until all the steam escapes from the pressure cooker before opening it, then you can open the pressure cooker. You can remove the lid.

**WARNING:** Never open the lid by force. At the end of the cooking time, turn off the stove and allow the pressure in the pressure cooker to fall completely. Take the pressure cooker off the stove and place it on a suitable surface. You can release the pressure using the following 3 methods:

1) Allow the pressure cooker to cool down: Wait until the red pin on the safety valve disappears completely. This is the recommended method for mashed or foaming food.

2) Slowly switch the pressure valve from Position II to position . Do not switch the valve directly from position II to position . First switch it from position II to position I and wait a few seconds and then switch it from position I to position . If you are cooking at level I, you can turn it directly from position I to position .

**WARNING:** Escaping steam is extremely hot.

3.) Rapid pressure release: Hold the pressure cooker under cold running water and allow the water to slowly flow along the lid (not only over the plastic parts), until the red safety valve (overpressure plug) completely disappears from view. Do not place the pressure cooker into water. As soon as the red pin (overpressure plug) disappears completely, the pressure cooker is depressurised. Now set the pressure valve to position . You can turn off the pressure cooker once all the steam has been released. You can open the lid.

**WARNING:** Never open the lid by force and never tamper with the safety system. The pressure cooker can only be opened when it is no longer pressurised.

## MAINTENANCE AND CLEANING

Clean out and wash the pressure cooker after every use using hot water and dishwashing detergent. Do not use any course, abrasive or caustic cleaners or agents containing chlorine.

The pot of the pressure cooker can be washed in a dishwasher – THE LID CANNOT.

## CLEANING THE POT

- 1) Always wash the cookware in hot water using detergent in order to remove all food residues. Rinse and dry the product. Then wipe with a drop of oil to maintain the quality surface. Use a paper towel to remove excess oil (treat your product in this way to keep it in perfect condition).
- 2) Ensure that the size of the hotplate on the stove corresponds to the size of your product and that it is not wider than the edge of the cookware. This will prevent the exterior surface from overheating. Take advantage of the cookware's thermal heat accumulation property, which helps retain heat in the container longer and saves energy
- 3) Never leave the cookware on a hotplate without supervision. Allow the cookware to cool down before cleaning it.
- 4) To remove light stains after cooking (baked on stains), leave the cookware to soak in hot water with detergent and then wipe dry using a soft cloth. If the pot becomes stained inside, heat up some white vinegar and then wash as usual. These stains have no effect on the properties of the product.
- 5) We recommend that you do not use metal utensils on the stainless steel surface or cut food inside the pressure cooker.
- 6) Stainless steel cookware is very easy to maintain and clean; when cleaning by hand, use only soft wipes and sponges that will not scratch the surface. Do not use aggressive chemical products. It is possible to wash the cookware in a dishwasher ONLY THE POT, BUT NOT THE LID – however avoid hard water and excessively aggressive cleaning agents, which could cause the surface colour of the cookware to change. Nevertheless, these changes have no effect on the functionality or health properties of the cookware.
- 7) To ensure that the product serves you for a long time, treat the cookware with care and try not to scratch its surface.

## GASKET RING

Clean the gasket ring by rinsing it under hot running water and dry it. You should replace the gasket ring when it becomes hard (starts to turn brown).

## LID AND SAFETY VALVE

It is necessary to rinse inside and out under running water in regular intervals based on cooking frequency

## PRESSURE VALVE

Cleaning the pressure valve: separate the plastic top. Do this by pushing the valve down and turning it fully to the left. You can now lift and remove it upwards from its mount. Clean it under running water and put it back on.

Please make sure that when returning the valve that it falls back into the grooves and secure it in place by turning it.

## HANDLES

It is always sufficient to simply rinse with water. Regularly check the strength of the handles on the pressure cooker. If you notice that the handle is loose then tighten it using a screwdriver.

## STORAGE

After washing and drying the pressure cooker, you should store it in a clean, dry and protected place. Do not place the lid on the pot and do not close it, only place it on the pot upside down or loosely away from the pot.

## FREQUENTLY ASKED QUESTIONS

If it takes a long time to achieve a boil:

- The hotplate is not hot enough – turn it up to the maximum level

If the red pin of the safety valve (overpressure plug) does not come out - steam is escaping from the valve while cooking:

- During the first few minutes this is quite normal (pressure is only starting to accumulate)
- If this condition continues, check the following:
  - a) is the hotplate hot enough? If not, turn up the power
  - b) is there enough liquid inside the pressure cooker? If not, add more according to the requirements
  - c) is the pressure valve set to I or II? If not, make sure that it is
  - d) is the pressure cooker closed properly? If not, make sure that it is
  - e) is the gasket ring or edge of the pot damaged? Please check it

If while cooking the red pin of the safety valve (overpressure plug) comes out and no steam is escaping from the pressure valve:

- Hold the pressure cooker under cold running water to reduce the pressure
- Open the pressure cooker
- Clean out the pressure valve and the safety valve

If steam is escaping around the lid, check:

- Is the lid closed properly? If not, make sure that it is

Is the safety ring properly seated?

- Condition of the safety ring (replace it if necessary)
- Is the lid, the safety valve and pressure valve clean? If not, clean it.
- Is the edge of the pot in order? Do not use the pressure cooker if it is damaged, please contact a service centre

If the lid cannot be opened

- Check that the safety valve has gone down completely. If not, release the residual pressure.
- Cool down the pressure cooker using running cold water if necessary

If the food being cooked is not cooked enough or perhaps overcooked, check the following: Cooking time (too short or too long):

- Hotplate power output
- Correct pressure valve setting
- Amount of liquid

If the cooked food has baked on to the pot:

- Leave the remains to soak before cleaning – then remove them.
- Do not use any caustic cleaners or agents containing chlorine.





## COOKING TIME TABLE

Cooking time is affected by many factors. Use the information provided below as a guide, but the actual cooking time may differ depending on your pressure cooker, the stove that is used, the amount or quantity of the food.

TYPE	TIME IN Min	PRESSURE LEVEL
<b>Legumes – pre-soaked</b>		
Lentils.....	20 to 30 min .....	Level II
Peas.....	20 to 30 min .....	Level II
Beans (pre-soaked).....	35 to 40 min .....	Level II
<b>Cooked/stewed vegetables</b>		
Pineapple (slices) .....	6 to 8 min .....	Level I
Artichoke.....	7 to 9 min .....	Level II
White rice (long grain) .....	4 min.....	Level II
White rice (short grain).....	6 min.....	Level II
Potatoes .....	10 min.....	Level II
Broccoli.....	5 to 6 min .....	Level I
Peach (dried).....	4 to 7 min .....	Level I
Celery .....	5 to 7 min .....	Level II
Onion (whole).....	10 min.....	Level II
Lemons .....	3 to 5 min .....	Level I
Butter bean .....	6 to 10 min .....	Level II
Brown rice (long grain) .....	12 min.....	Level II
Brown rice (short grain).....	12 min.....	Level II
Mushrooms .....	8 to 10 min .....	Level II
Grapes (for making marmalade).....	2 to 4 min .....	Level I
Asparagus .....	4 min.....	Level I
Apples .....	3 to 5 min .....	Level I
Strawberries (for making marmalade) .....	2 to 4 min .....	Level I
Corn on the cob .....	20 min.....	Level II
Cauliflower.....	5 to 7 min .....	Level II
Apricots .....	4 to 7 min .....	Level I
Carrot .....	7 to 10 min .....	Level II
Oranges.....	3 to 5 min .....	Level I
Tomato purée .....	8 min.....	Level I
Tomatoes.....	3 to 5 min .....	Level II
Brussels sprouts .....	5 to 6 min .....	Level I
Beet.....	15 to 18 min .....	Level II
Spinach (fresh or frozen) chopped .....	3 to 4 min .....	Level I
Black-eyed peas .....	12 to 15 min .....	Level II
Vegetable mix.....	10 to 12 min .....	Level II
Cabbage .....	5 to 7 min .....	Level I
<b>Pasta</b>		
Macaroni .....	12 to 15 min .....	Level II
Spaghetti .....	12 to 15 min .....	Level II
<b>Meat and poultry</b>		
Beef cubes 25 mm (700 g).....	25 to 30 min .....	Level II
Beef (brisket, fresh or canned) 900 – 1400g.....	35 to 40 min .....	Level II
Beef (short ribs) .....	20 to 25 min .....	Level II
Lamb.....	25 to 30 min .....	Level II
Duck (quarters) .....	25 to 30 min .....	Level II
Duck (whole).....	30 to 35 min .....	Level II
Chicken (whole) 900 – 1400g.....	25 to 30 min .....	Level II
Chicken cubes.....	20 to 25 min .....	Level II
<b>Fish and seafood</b>		
Lobster 700 – 900g.....	10 to 12 min .....	Level II
Carp.....	8 to 10 min .....	Level I
Mackerel.....	6 to 8 min .....	Level I
Mussels .....	6 to 8 min .....	Level II
Salmon steak (5 cm thick).....	4 to 6 min .....	Level I



## COMPLAINTS, MAINTENANCE

Adhere to all the provisions provided in this user's manual. The pressure cooker is designed for household use only. Adhere to all the maintenance fundamentals for the stainless steel pressure cooker, its treatment and cleaning, including frequency. Standard maintenance and repairs, which may be performed by the user and it is not necessary to contact a service centre. In the event that the gasket rubber, the valve system or another defect, contact your vendor or the service centre of **Fast ČR, a.s.** directly. The current list is available at [www.fastcr.cz](http://www.fastcr.cz).

## WARRANTY

This product is covered by an extended 5-year warranty that is valid from the date of purchase of the product.

### The warranty does not cover the following:

- the product was not used properly or was used in a way that contradicts this user's manual
- the product was modified or repaired at an unauthorised service centre or by an unauthorised person and original parts were not used for the repair.
- the damage was caused by a fall or impact

## WARRANTY CARD

This product is covered by a 60-month warranty period from the date of purchase of the product. The warranty period commences on the date of purchase. The warranty card must be presented together with a valid proof of purchase of the given product. The provision of the warranty does not affect the rights of the buyer, which relate to the purchase of a product according to special legal regulations. Other relationships between the vendor and the buyer are governed by the valid provisions of the Civil Code.

### PRODUCT (Name/Product number/EAN):

### SALE DATE:

### VENDOR (business name and address):

### STAMP AND SIGNATURE OF THE VENDOR/STORE:

This warranty card must be presented with every lodged complaint.

Always carefully store this warranty card.

The warranty card is only valid if it is legible and properly filled out with the stamp and signature of the vendor/store, sale date, address of the vendor/store and product description.

### The warranty does not cover the following:

- the product was not used properly or was used in a way that contradicts this user's manual
- the product was modified or repaired at an unauthorised service centre or by an unauthorised person and original parts were not used for the repair.
- the damage was caused by a fall or impact

the product was worn out by standard use excluding material defects

Lodge the justified complaint with your vendor/store where you purchased the given product or directly at a service centre of **Fast ČR, a.s.** The current list is available at [www.fastcr.cz](http://www.fastcr.cz).